



Read this document carefully before using this device. The guarantee will be expired by damaging of the device if you don't attend to the directions in the user manual. Also we don't accept any compensations for personal injury, material damage or capital disadvantages.

## ENDA ATP4 MULTI FUNCTIONAL ANALOG TIMER

Thank you for choosing ENDA ATP4 Multi Functional Analog Timer

- \* 48 x 48mm sized.
- \* Triggering whit supply voltage.
- \* Triggering output (OUT1).
- \* Contact output for timing function (OUT2).
- \* 6 Different timing modes for OUT2 (A, B, C, D, E, F).
- \* 6 Different timing unit selections for OUT2 (S,10S, M, 10M, H, 10H).
- \* Suitable for 8/11 pin octal or 7/10 screw-terminal connection.
- \* Start, reset and gate inputs for 10 pins screw-terminal or 11 pin octal connector.
- \* CE marked according to European Norms.

### ORDER CODE

ATP4-K07-UV-01

Product Basic Code	Scale
Panel Mounted	01 0 ..... 1,2
Multi Function Analog Timer	03 0 ..... 3
Connection Type	12 0 ..... 12
7 Pins screw-terminal K07	30 0 ..... 30
10 Pins screw-terminal K10	60 0 ..... 60
8 Pins octal S08	Supply Voltage
11 Pins octal S11	UV 90-250V AC
	LV 24V AC/DC

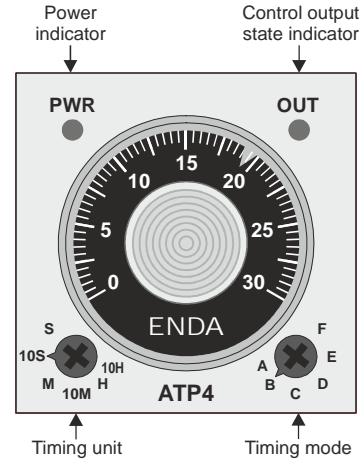

**CE** **RoHS**  
Compliant

### Connection Diagram



ENDA ATP4 is intended for installation in control panels. Make sure that the device is used only for intended purpose. The electrical connections must be carried on by a qualified staff and must be according to the relevant locally applicable regulations. During an installation, all of the cables that are connected to the device must be free of electrical power. The device must be protected against inadmissible humidity, vibrations, severe soiling. Make sure that the operation temperature is not exceeded. All input and output lines that are not connected to the supply network must be laid out as shielded and twisted cables. These cables should not be close to the power cables or components. The shielding must be grounded on the instrument side.

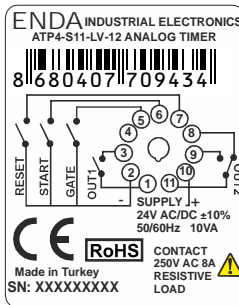
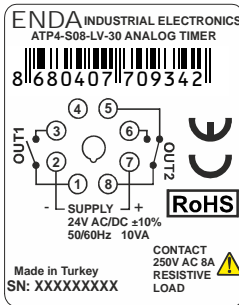
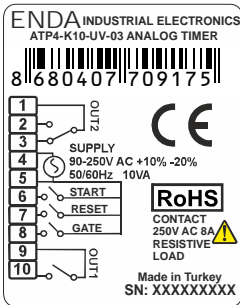
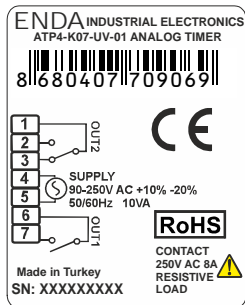

### NOTE :

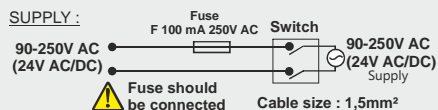

- 1) Mains supply cords shall meet the requirements of IEC 60227 or IEC 60245.
- 2) In accordance with the safety regulations, the power supply shall bring the identification of the relevant instrument and it should be easily accessible by the operator.

## Technical Specifications

ENVIRONMENTAL CONDITIONS	
Ambient/storage temperature	0 ... +50°C/-25 ... 70°C (There shouldn't be icing or condensation on the environment.)
Relative humidity	80% Relative humidity for temperatures up to 31°C, decreasing linearly to 50% at 40°C.
Rated pollution degree	According to EN 60529 Front panel : IP50 Rear panel : IP20
Height	Maximum 2000m
Do not use the device in locations subject to corrosive and flammable gasses.	

ELECTRICAL CHARACTERISTICS	
Supply voltage	90-250V AC, 50/60Hz or 24V AC ±%10, 50/60Hz or 24V DC ±%10
Power consumption	Maximum 10VA
Connection	8/11 pins octal connector or 7/10 pins screw-terminal.
Scale	0-1.2, 0-3, 0-12, 0-30 or 0-60.
Reset time	0.3 Seconds for ATP4-UV, 0.01 seconds for ATP4-LV.
Accuracy	Depending on the effect of supply voltage : max %0.2 Depending on the set value settings : max %5 Depending on the effect of temperature : max %1
EMC	EN 61326-1: 2006
Safety requirements	EN 61010-1: 2010 (pollution degree 2, over voltage category II)
Insulation test voltage	3kV AC min. 1 minute, 4,2kV DC min. 1 minute.

OUTPUTS	
Trigger output (OUT1)	Relay: 250V AC, 8A (resistive load), NC
Control output (OUT2)	Relay: 250V AC, 8A (resistive load), NO+NC
Life expectancy for relay	Without load 30.000.000 operation; 250V AC, 8A resistive load 100.000 operation.
Control output state	OUT Led lights up when there is power at the output control, it is flashes as long as the timer is running.

CONTROL	
Timing function	A, B, C, D, E, F Modes can be selected on device.
Timing unit	Second, 10 seconds, minute, 10 minutes, hour, 10 hours units can be selected on device.
Start input	Switch inputs for 10 screw-terminal or 11 pin octal connector models. (Pulsing time min. 3ms.)
Reset input	Switch inputs for 10 screw-terminal or 11 pin octal connector models. (Pulsing time min. 3ms.)
Gate input	Switch inputs for 10 screw-terminal or 11 pin octal connector models. (Pulsing time min. 3ms.)

HOUSING	
Housing type	Suitable for flush-panel mounting or rail mountable 8/11 pin octal connector.
Dimensions	W48xH48xD82mm
Weight	Approx. 170g (after packing)
Enclosure material	Self extinguishing plastics
While cleaning the device, solvents (thinner, benzene, acid etc.) or corrosive materials must not be used.	

### Dimensions

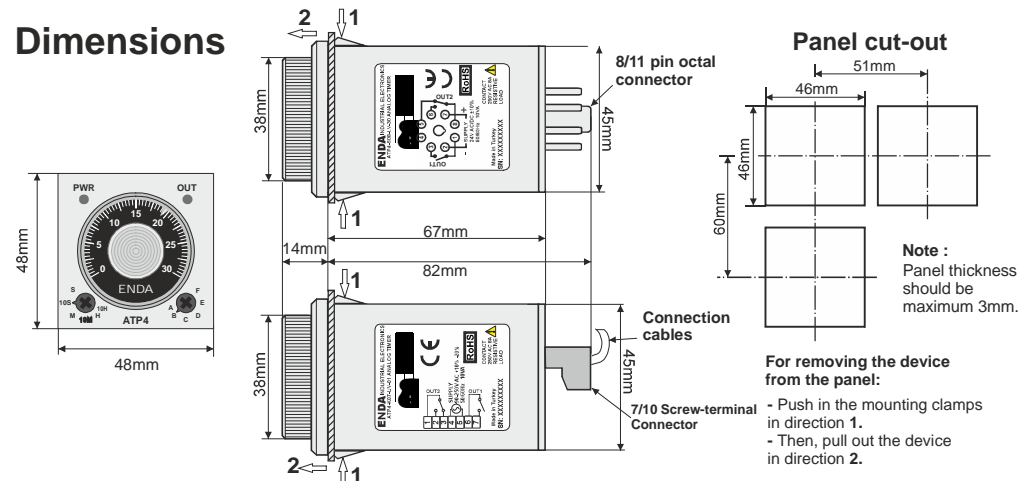

### For removing the device from the panel:

- Push in the mounting clamps in direction 1.
- Then, pull out the device in direction 2.

up to date: 09052019, modification reserved and can be change any time previous notice

# OUTPUT CONTROL

## ATP4-K07-xV-xx / ATP4-S08-xV-xx

For 7 Screw-terminal / 8 Pin octal connection.

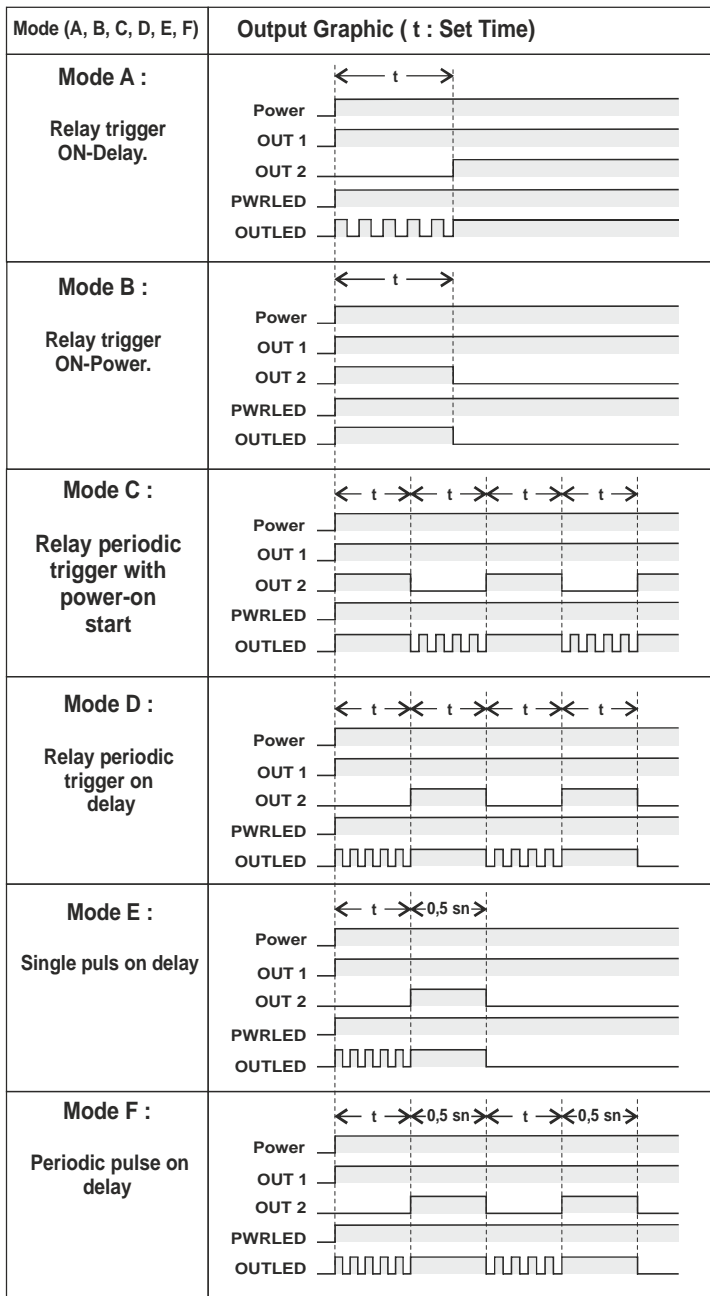

### Statements & Descriptions

- A- Relay trigger ON-Delay.  
When Power on, end of the settled period switch ON.
- B- Relay trigger ON-Power.  
When Power on, switch immediately ON, end of the settled period switch OFF.
- C- Relay periodic trigger with power-on.  
When Power on, switch immediately ON, end of the settled period switch OFF, process continues periodically.
- D- Relay periodic trigger on delay.  
When Power on, end of the settled period switch ON, process continues periodically.
- E- Single puls on delay.  
When Power on, end of the settled period switch ON, after 0.5 sec OFF.
- F- Periodic pulse on delay.  
When Power on, end of the settled period switch OFF, after 0.5 sec OFF, process continues periodically.

## ATP4-K10-xV-xx / ATP4-S11-xV-xx

For 10 Screw-terminal / 11 Pin octal connection.  
Start, reset and gate inputs are available.

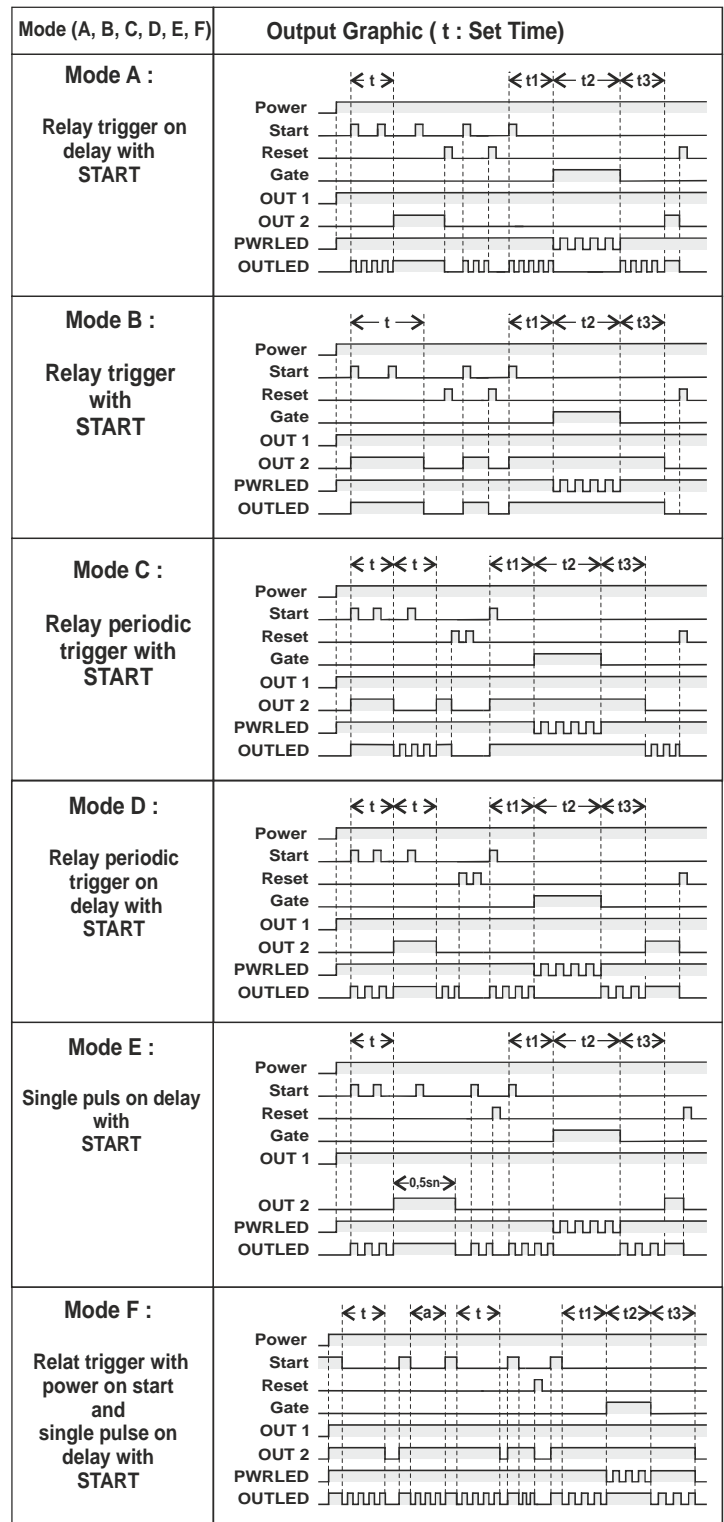

t : Set time , t2 : Gate signal duration , t > a

t = t1 + t3

During the Gate signal (t2), the timer stops.